



**COOLINGCARE
ADVANCED CHANNEL
CLEANING SOLUTION**



AUTOMATIC MAINTENANCE, DIAGNOSTICS
& CONSERVATION OF COOLING CHANNELS

INTRODUCTION

A successful molding operation requires the efficient use of its equipment. Quality, cycle time and up-time measured by O.E.E (Overall Equipment Effectiveness) indicates the percentage of manufacturing time that is truly productive. The cooling portion of the molding cycle is typically 50% of the molding cycle making it one of the most important areas to be managed.

To reduce cooling cycle times the mold designer incorporates cooling channels which are often complimented with 3D additive conformal cooling inserts. The result is often a significant reduction in overall molding cycle time with the corresponding savings in costs versus conventional cooling.

Today's challenge is maintaining this performance over the lifetime of the tool.

Overtime the cooling channels become restricted with scale and corrosion build up and can even become completely clogged. The result negatively impacts O.E.E. as cycle times become longer and scrap rates increase. Even with operator adjustments the cooling loss cannot be overcome.

The new CoolingCare advanced channel cleaning equipment with Industry 4.0 capabilities is the solution to return the O.E.E. to its original performance levels. Patented technology combines a chemical and mechanical action to free and dissolve the unwanted material. The control panel automates the entire process supporting autonomous cleaning without the need of supervision. A simple text message notifies the operators when the process is complete.



IDENTIFY THE PROBLEM

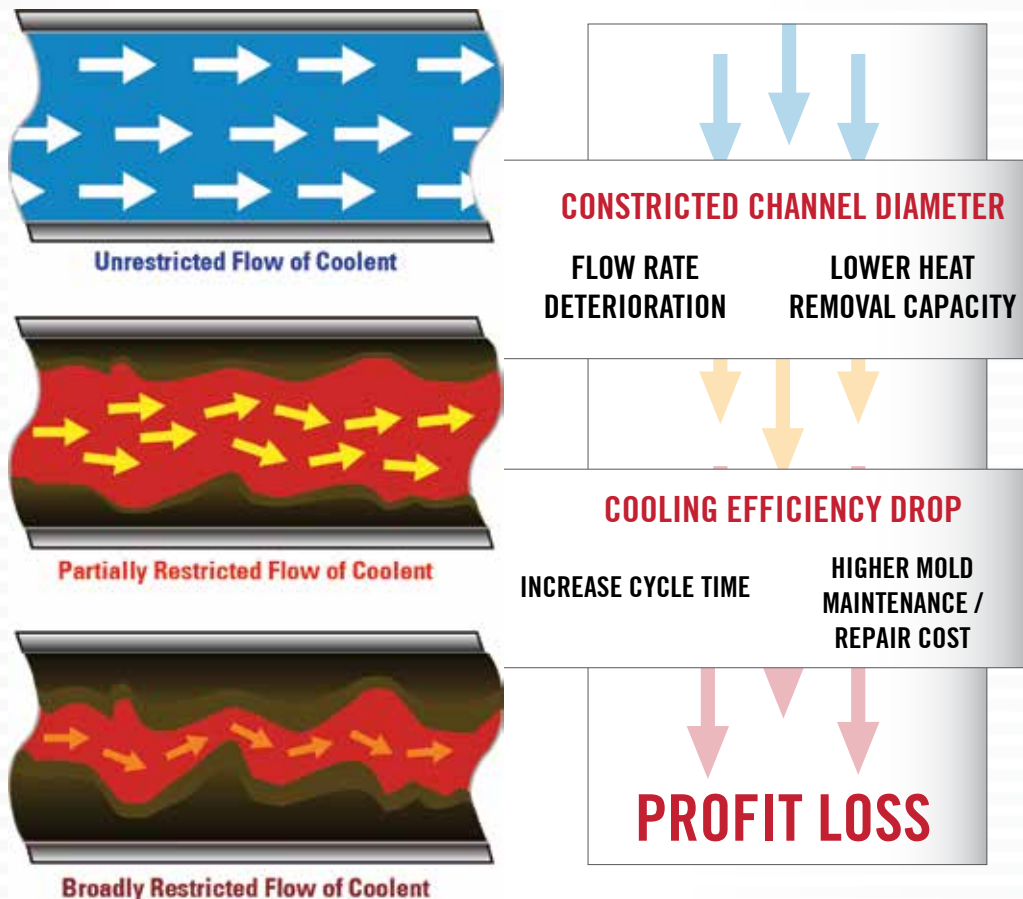

CONSTRICTED COOLING CHANNELS

Comprehensive Maintenance of Cooling Channels

The capacity to absorb heat is directly proportional to heat conductivity of surfaces taking away the heat.

MATERIAL	Calcium carbonate scale	Calcium sulphate scale	Calcium silicate scale	1.2343 steel
HEAT CONDUCTIVITY W/mK	0,6 – 6	2,3	0,3	24

Due to their low heat conductivity, scale and corrosion will greatly affect mold cooling efficiency and cause:

- Drop in production (increased cycle times and scrap rate)
- Part dimension inconsistencies between cavities in the same tool.
- Adjustment and correction of injection parameters with every production start-up

Influence of lime deposits on cooling time

Scale formation depends primarily on water hardness and rises substantially in temperatures above 60°C. Areas with little or zero flow rates are more prone to scale deposits and corrosion issues.

Thermovision picture of a mold with a clogged cooling channel:

- Temperature rise in the second cavity
- Unstable injection molding conditions

Different Scale Types

We offer media to address various scale types.

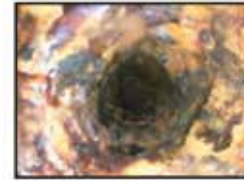

Calcium Carbonate/ Calcium Silicate/Iron



Corrosion Products Rust/Calcium Carbonate

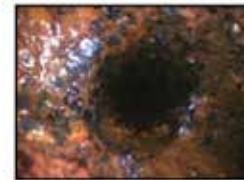

Calcium Sulphate/ Iron Oxides

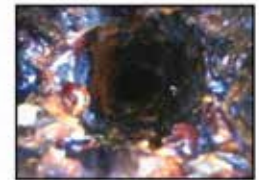

Scale with a high amount of Iron Oxides

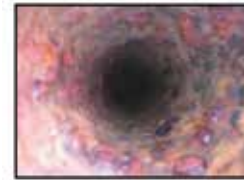

Calcium Carbonate/ Calcium Sulphate



Calcium Carbonate

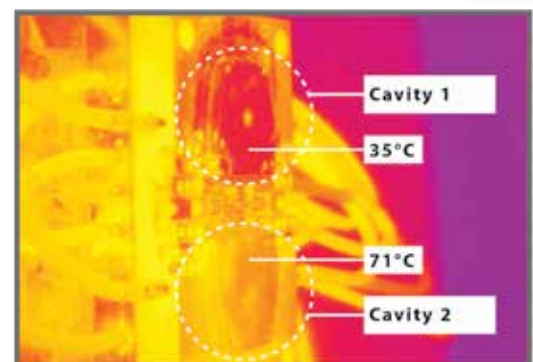
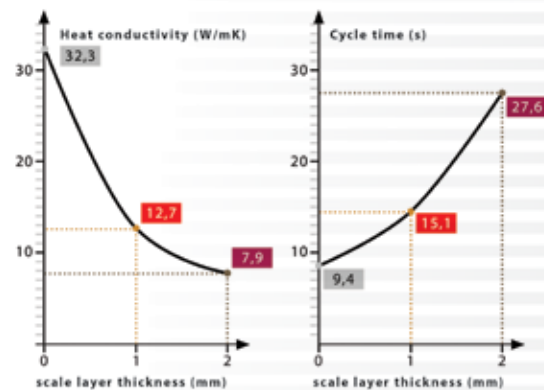

CA SERIES - AUTOMATIC CLEANING, DIAGNOSTICS & CONSERVATION OF COOLING CHANNELS

AVAILABLE IN SIX AND TWO CIRCUIT VERSIONS

FEATURES

- 10" touchscreen user interface
- Fully Automatic - operators are only required to connect the mold and define the channels to be cleaned
- A unique design allowing for independent and efficient cleaning of channels regardless of their length and diameter
- Advanced archiving system supporting the correct mold maintenance throughout the entire mold operation time
- High pulsation dynamics of cleaning allows for less aggressive cleaning media, safe for steel, aluminum, copper and bronze
- Intelligent monitoring of the cleaning process - the device recognizes when the desired flow rate values are reached and finishes cleaning



User Friendly Interface

CA-6 & CA-2 FUNCTIONS

Multiple Functions Allow for Comprehensive Maintenance of Cooling Channels



- 1 LEAK TEST** - Channel leak verification before and after cleaning. Pneumatic & Hydraulic
- 2 BLOCKAGE TEST** - Detection of clogged channels linked to unclogging procedure
- 3 DIAGNOSTICS** - Flow rate measurement of every channel, comparison of the results with the archived data
- 4 CLEANING** - Patent pending channel cleaning process based on two-way pulsating movement of cleaning media
- 5 NEUTRALIZATION & CONSERVATION** - Protection of channels with corrosion inhibitors at the end of the rinsing process
- 6 REPORTING** - Record of all process parameters in the database, export of cleaning reports to external devices

COOLINGCARE - INDUSTRY 4.0 TECHNOLOGY

Featuring: Self-Optimization, Intelligent Service and CoolingCare Connect

A trifecta of cutting edge features positions CoolingCare as a leader for Industry 4.0

CoolingCare features cutting edge functions for comprehensive all-in-one maintenance of cooling channels.

Self-Optimization: An advanced monitoring feature enables the machine to clean until a pre-defined flow rate is obtained or the flow rate becomes consistent. This intelligent feature drives efficiency by adjusting the cleaning cycle accordingly. The ultimate results are maximum cleaning efficiency, and reduced labor costs.

Intelligent Service: uses a built in modem for on-line diagnostics and service. This allows for remote diagnostics of machine malfunction by a service technician. Such a feature reduces and may prevent downtime for machine service related issues.



CoolingCare Connect allows an operator to *communicate with the machine via text messages*. The machine will send a message to the phone of the defined user alerting them of an alarm (up to 17 alarms can be triggered) for unexpected events such as a failed pressure or blockage test, as well as process completion notifications for lights out cleaning. The operator can also send a test message "S" to the machine requesting its current status. The machine will automatically reply via text message informing the operator of its current mode/action. This feature requires a GSM card (user provided) to be placed in the modem of the machine for wireless external communications.



The CoolingCare Connect machine's database allows for the export of cleaning reports to external devices by means of a USB. CoolingCare Connect technology protects your investments, improves profitability, and provides a low maintenance solution to the high maintenance challenges surrounding cooling channels.

CASE STUDY 1

Design Specifications

TWO-CAVITY MOLD

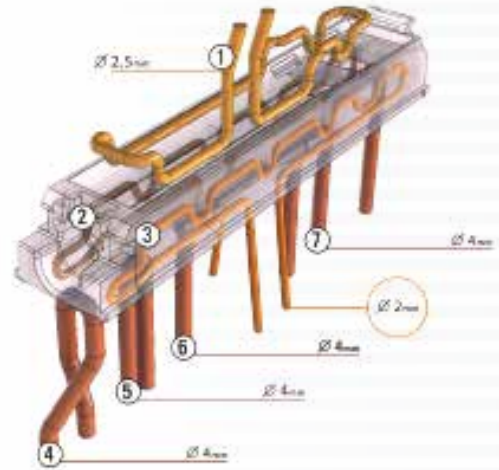

8 SECOND (44%) INCREASE IN CYCLE TIME AFTER 1 YEAR OF PRODUCTION

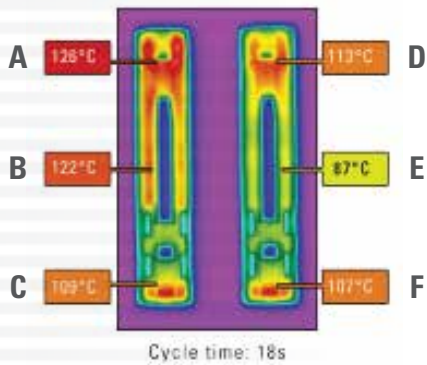

AFTER CLEANING OF CHANNELS RETURN TO 18 SECOND CYCLE TIME

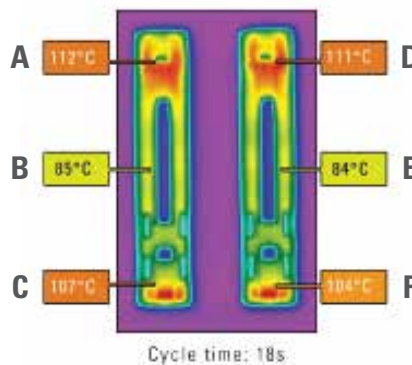

CYCLE TIME COMPARISON

Mold Area	Temp Before	Temp After	Temp Reduction
A	126 °C	112 °C	14 °C
B	122 °C	85 °C	37 °C
C	109 °C	107 °C	2 °C
D	113 °C	111 °C	2 °C
E	87 °C	84 °C	3 °C
F	107 °C	104 °C	3 °C

In order to obtain required part dimensional tolerances it was necessary to increase cycle time from 18 to 26 seconds.



FLOW RATE VALUES BEFORE AND AFTER FOUR HOURS OF CLEANING WITH COOLINGCARE CA-6*

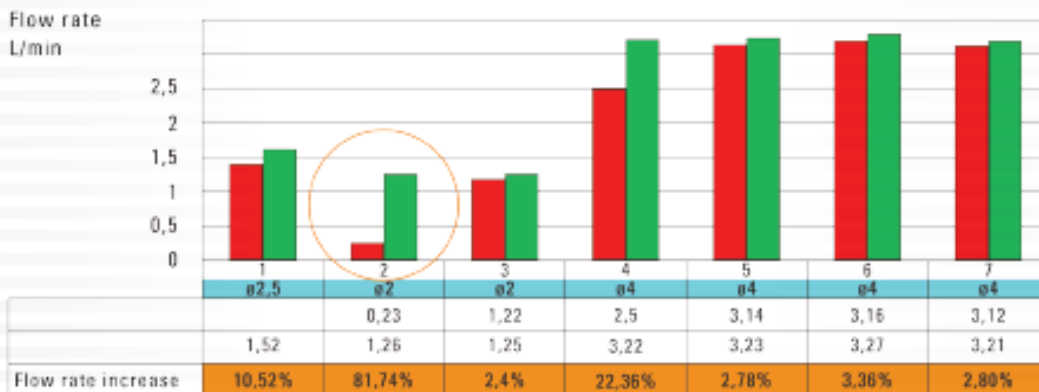

* Measured with CoolingCare CA-6 diagnostics module

CASE STUDY 2

Design Specifications

TWO-CAVITY MOLD

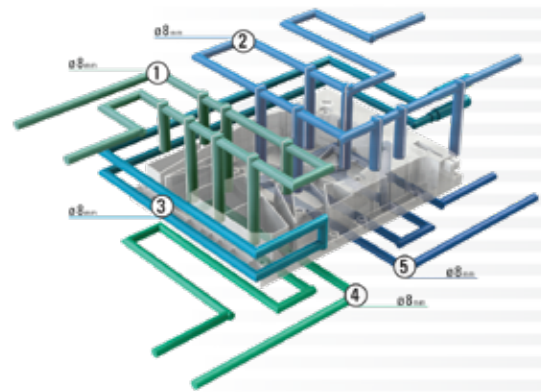

4 SECOND (9%) INCREASE IN CYCLE TIME AFTER 1 YEAR OF PRODUCTION

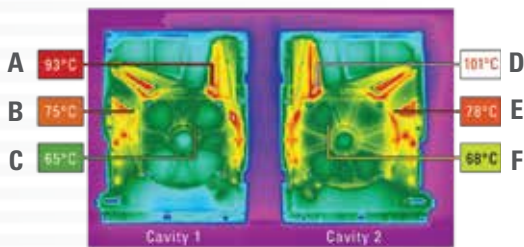

AFTER CLEANING OF CHANNELS RETURN TO 43 SECOND CYCLE TIME

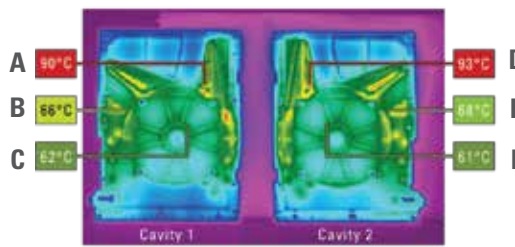

CYCLE TIME COMPARISON

Mold Area	Temp Before	Temp After	Temp Reduction
A	93 °C	90 °C	3 °C
B	75 °C	66 °C	9 °C
C	65 °C	62 °C	3 °C
D	101 °C	93 °C	8 °C
E	78 °C	68 °C	10 °C
F	68 °C	61 °C	7 °C

After one year of use cycle time increased from 43 seconds to 47 seconds.



After cleaning cycle time decreased back to 43 seconds.

FLOW RATE VALUES BEFORE AND AFTER FOUR HOURS OF CLEANING WITH COOLINGCARE CA-6*

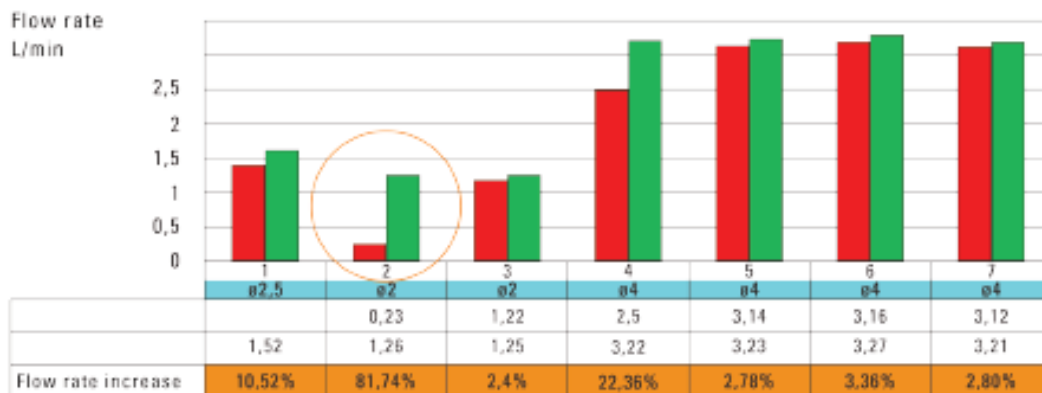

* Measured with CoolingCare CA-6 diagnostics module



COOLINGCARE SYSTEMS & ACCESSORIES

2 CHANNEL

ITEM NUMBER	DESCRIPTION
CA-2NA	2 Channel, (1) 2kW Heater, Basic Leak Detection System
CA-2NA2H	2 Channel, (2) 2kW Heaters, Basic Leak Detection System
CA-2NAP	2 Channel, (1) 2kW Heater, Precise Leak Detection System
CA-2NA2HP	2 Channel, (2) 2kW Heaters, Precise Leak Detection System



CCK2C200 200 SERIES KIT FOR 2 CHANNEL 3/8 HOSE

KIT CONTAINS		
QUANTITY	ITEM NUMBER	DESCRIPTION
1 EACH	TS4TUBE8OZ	Krytox Thread Sealant
4 EACH	BPB8-6	1/2 To 3/8 NPT Bushing
4 EACH	JP253	3/8" NPT 200 Series Plug
8 EACH	JSL0206	200 Series Jiffy-Lok® Coupler For 3/8" Hose ID
(2) 10' PIECES	801-6RED	3/8" Red Push-Lok® Hose
(2) 10' PIECES	801-6BLUE	3/8" Blue Push-Lok® Hose



CCK2C300 300 SERIES KIT FOR 2 CHANNEL 1/2 HOSE

KIT CONTAINS		
QUANTITY	ITEM NUMBER	DESCRIPTION
1 EACH	TS4TUBE8OZ	Krytox Thread Sealant
4 EACH	JP354	1/2" NPT 300 Series Plug
4 EACH	JSL0308	300 Series Push-Lok Coupler for 1/2" Hose ID
(2) 10' PIECES	801-6RED	1/2" Red Push-Lok® Hose
(2) 10' PIECES	801-6BLUE	1/2" Blue Push-Lok® Hose



CCK2C500 500 SERIES KIT FOR 2 CHANNEL 1/2 HOSE

KIT CONTAINS		
QUANTITY	ITEM NUMBER	DESCRIPTION
1 EACH	TS4TUBE8OZ	Krytox Thread Sealant
4 EACH	JP554	1/2" NPT 500 Series Plug
4 EACH	JSL0504	500 Series Push-Lok Coupler for 1/2" Hose ID
(2) 10' PIECES	801-6RED	1/2" Red Push-Lok® Hose
(2) 10' PIECES	801-6BLUE	1/2" Blue Push-Lok® Hose



ITEM No.	DESCRIPTION
DS1	Cleaning Media, 10kg (22lbs), suitable for sediment/scale with high concentration of iron oxide, includes corrosion inhibitors
DS2	Cleaning Media, 10kg (22lbs), suitable for sediment/scale with high concentration of calcium carbonate, includes corrosion inhibitors
CCHTR2KW	CoolinCare Additional Heating Power +2kW, add on kit
CCMLCP	CoolingCare Cleaning Media Level Probe, add on kit



COOLINGCARE SYSTEMS & ACCESSORIES

6 CHANNEL

ITEM NUMBER	DESCRIPTION
CA-6NA	6 Channel, (1) 2kW Heater, Basic Leak Detection System
CA-6NA2H	6 Channel, (2) 2kW Heaters, Basic Leak Detection System
CA-6NAP	6 Channel, (1) 2kW Heater, Precise Leak Detection System
CA-6NA2HP	6 Channel, (2) 2kW Heaters, Precise Leak Detection System



CA-6

CCK6C200 200 SERIES KIT FOR 6 CHANNEL 3/8 HOSE

KIT CONTAINS		
QUANTITY	ITEM NUMBER	DESCRIPTION
1 EACH	TS4TUBE8OZ	Krytox Thread Sealant
12 EACH	BPB8-6	1/2 To 3/8 NPT Bushing
12 EACH	JP253	3/8" NPT 200 Series Plug
24 EACH	JSL0206	200 Series Jiffy-Lok® Coupler For 3/8" Hose ID
(6) 10' PIECES	801-6RED	3/8" Red Push-Lok® Hose
(6) 10' PIECES	801-6BLUE	3/8" Blue Push-Lok® Hose



CCK6C300 300 SERIES KIT FOR 6 CHANNEL 1/2 HOSE

KIT CONTAINS		
QUANTITY	ITEM NUMBER	DESCRIPTION
1 EACH	TS4TUBE8OZ	Krytox Thread Sealant
12 EACH	JP354	1/2" NPT 300 Series Plug
24 EACH	JSL0308	300 Series Push-Lok Coupler for 1/2" Hose ID
(6) 10' PIECES	801-6RED	1/2" Red Push-Lok® Hose
(6) 10' PIECES	801-6BLUE	1/2" Blue Push-Lok® Hose



CCK6C500 500 SERIES KIT FOR 6 CHANNEL 1/2 HOSE

KIT CONTAINS		
QUANTITY	ITEM NUMBER	DESCRIPTION
1 EACH	TS4TUBE8OZ	Krytox Thread Sealant
12 EACH	JP554	1/2" NPT 500 Series Plug
24 EACH	JSL0504	500 Series Push-Lok Coupler for 1/2" Hose ID
(6) 10' PIECES	801-6RED	1/2" Red Push-Lok® Hose
(6) 10' PIECES	801-6BLUE	1/2" Blue Push-Lok® Hose



ITEM No.	DESCRIPTION
DS1	Cleaning Media, 10kg (22lbs), suitable for sediment/scale with high concentration of iron oxide, includes corrosion inhibitors
DS2	Cleaning Media, 10kg (22lbs), suitable for sediment/scale with high concentration of calcium carbonate, includes corrosion inhibitors
CCHTR2KW	CoolinCare Additional Heating Power +2kW, add on kit
CCMLCP	CoolingCare Cleaning Media Level Probe, add on kit

CLEANING MEDIA, HEATERS & LEAK DETECTION

MEDIA

Cleaning media is required for use in the CoolingCare System. The media comes in powder form and is dispersed via a filtration basket (see images below). Please reference the User Manual that comes with your unit for complete details.

Choosing which media to order will depend on the type of sediment/corrosion in your channels.

DS1 - 10kg (1 box contains (4) 2.5kg bricks)

DS1 is formulated for cleaning sediment with high concentrations of iron oxides/corrosion by-products. Scale with high amounts of iron oxide will be reddish/brown in color. To test if the iron oxide content is high move a magnet under the plastic box containing the scale particles. If the particles follow the movement of the magnet, the content is high in iron oxides. This formula includes corrosion inhibitors and surfactants.

DS2 - 10kg (1 box contains (4) 2.5kg bricks)

DS2 is formulated for cleaning scale based on calcium and magnesium carbonates. The calcium carbonate scale is usually white or yellowish in color. Please bear in mind the composition of scale will usually have different ingredients, the only difference will be the ratio of their concentration. This formula includes corrosion inhibitors and surfactants.



2.5kg vacuum packed powder media
4 bricks/box

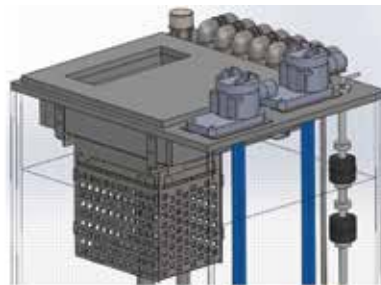

* Media should be disposed of in accordance with local, state and federal regulations.

ADDITIONAL 2KW HEATER

Machines can be ordered with an additional 2kW heater for a total of 4kW of heating capacity. The additional heater reduces the heating time of the cleaning media by up to 50% (with one heater it takes approximately 40 minutes to reach to the required 122°F, with two heaters the time is reduced to only 25 minutes).

For large molds the use of (2) 2kW heaters is highly recommended to maintain the suggested 122°F temperature of cleaning media. Large mold bases absorb more heat from the media which would result in longer cleaning cycles and lessens the effectiveness of the cleaning process.

PRECISION LEAK DETECTION

Precision Leakage Detection option allows the machine to identify leaks as small as 100ml / 0.026 gallon. This allows the machine to quickly identify a leak/crack within the cooling channel circuit. This option shuts the machines pumps down avoiding any fluid losses.

Technical information	CA-2 two-channel	CA/6 six/channel
Cleaning media temperature	50 °C / 122 °F	50°C / 122 °F
Container 1 volume	100 L / 26.4 gallons	100 L / 26.4 gallons
Container 2 volume	40 L / 11.8 gallons	55 L / 14.5 gallons
Recommended compressed air supply pressure	8 bar / 116 psi	8 bar / 116 psi
Maximum operating pressure	8 bar / 116 psi	8 bar / 116 psi
Maximum air consumption	0.5 m ³ / min	0.75 m ³ / min
Number of feed pumps	1	3
Number of pulsators	2	6
Diagnostic pump maximum capacity	86 L / min / 22.7 gallons/min	86 L / min / 22.7 gallons/min
Feed pump maximum capacity	12 L / min / 3.17 gallons/min	12 L / min / 3.17 gallons/min
Control voltage	240 VAC	240 VAC
Power consumption	18A (2kW heating) 25A (4kW heating)	18A (2kW heating) 25A (4kW heating)
Tare weight	220 kg / 485 lbs	420 kg / 926 lbs
Dimensions (L x W x H)	1430 x 691 x 1480 [mm] / 56.2" x 27.2" x 55.8"	1980 x 743 x 1460 [mm] / 77.9" x 29.2" x 55.7"
Control Panel	Touch screen 10.1"	Touch screen 10.1"

Device	CA-2 / CA-6
--------	-------------

Cleaning Module

Full automation of the cleaning process	✓
Automatic drying of channels with compressed air	✓
Inlet and outlet filtration	✓
Media conductivity measurement	Manual
Separate tanks for cleaning and diagnostics media	✓
Integrated heating of cleaning media	✓
Run dry protection	✓
Automated container filling and emptying	✓
Flow reversal	✓

Diagnostic Module

Automatic diagnostics with unmanned switch to cleaning mode	✓
Overall verification of cooling line seal integrity (leak test)	✓
Software verifying patency of individual channels	✓
Automatic channel rinsing with water after cleaning process	✓
Record of all parameters/works for every mold	✓
Intelligent monitoring of channel flow rates: <ul style="list-style-type: none"> • Reach reference flow rate function • Reach stable flow rate function 	✓
Online machine diagnostic in case of device malfunction	✓
Built-in CoolingCare Connect module enabling communication between the machine and users	✓

Your One-Stop-Shop!

With tens of thousands of products to choose from, DME is your one-stop shop for everything molding. From complex undercuts solutions and plate control to standard pins, bushings and interlocks, the DME line of mold components will help you build or rebuild your mold base inside out, top to bottom. Industrial Supplies, Mold Bases, MUD Quick-Change, Control Systems, and Hot Runner solutions round out our extensive offering to truly be your one-stop shop.



World Headquarters
DME Company LLC
29111 Stephenson Highway
Madison Heights, MI 48071
800-626-6653 *toll-free tel*
248-398-6000 *tel*
888-808-4363 *toll-free fax*
www.dme.net *web*
dme@dme.net *e-mail*

DME of Canada Ltd.
6210 Northwest Drive
Mississauga, Ontario
Canada L4V 1J6
800-387-6600 *toll-free tel*
905-677-6370 *tel*
800-461-9965 *toll-free fax*
dme_canada@dme.net *e-mail*

DME Mexico / South America
Circuito el Marques Notre, No.55
Parque Industrial El Marqués
El Marqués, Querétaro, CP 76246
52.442.713.5666 *tel*
dme_mexico@milacron.com

eSTORE
store.milacron.com
Shop online 24/7.

